

MEGARADAR®

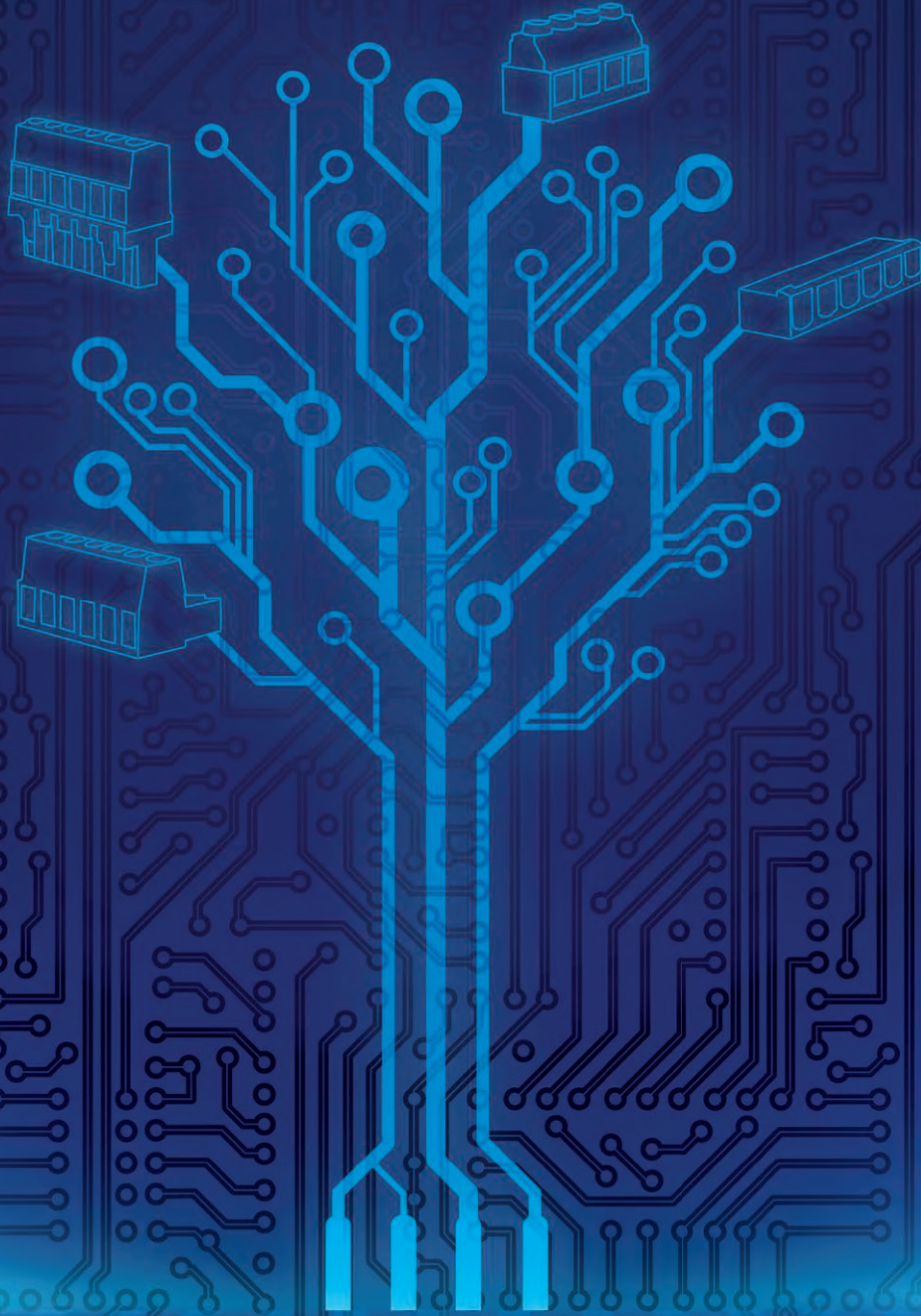

BASKILI DEVRE KLEMENSLERİ
FİYAT LİSTESİ

OCAK 2019

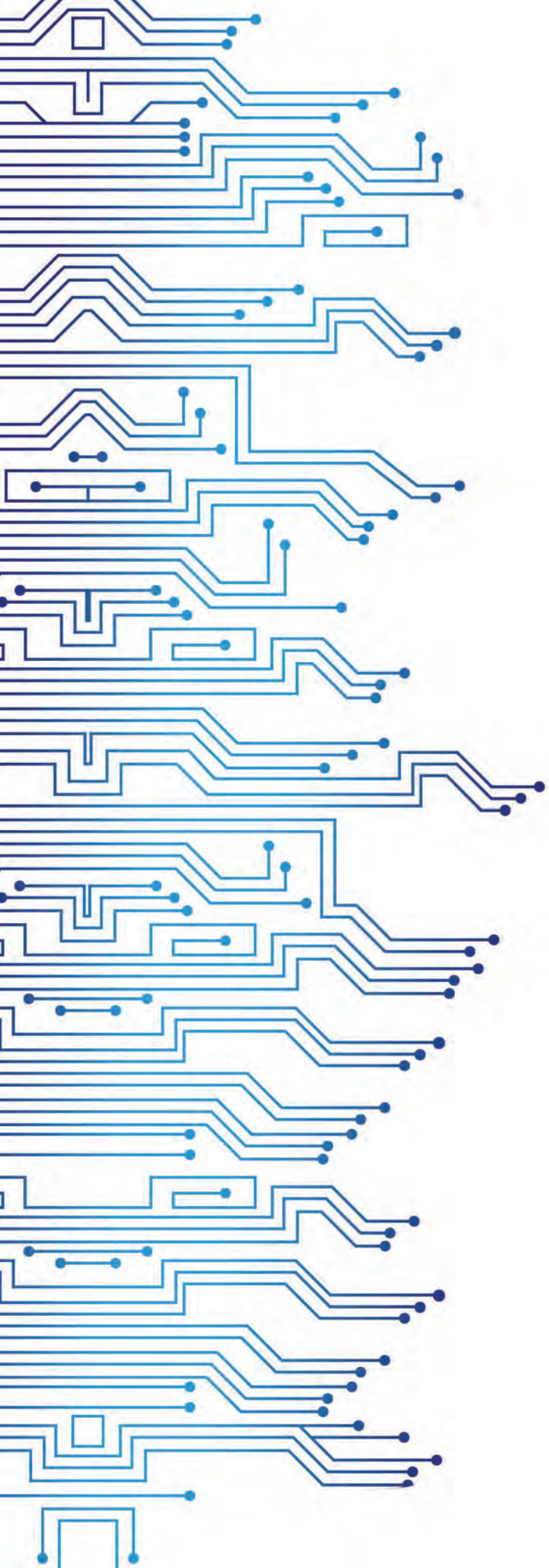

 **MEGARADAR®**

MEGARADAR

MEGA RADAR'ın
ileri teknoloji standartlarında ürettiği,
**GÜVENİLİR VE ÜSTÜN
PERFORMANS**

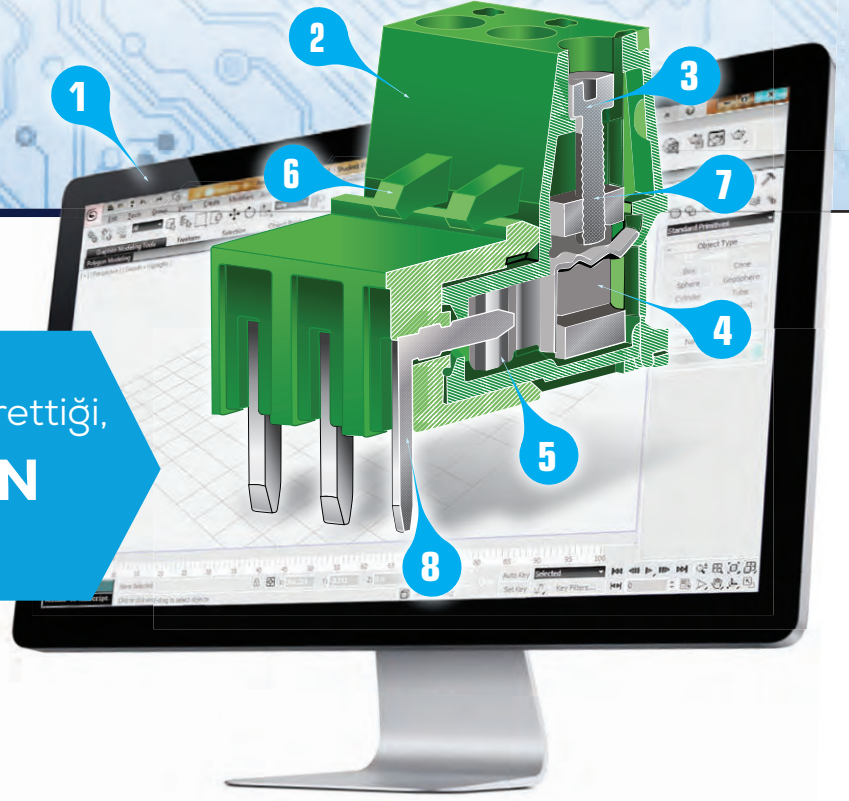

1

CAD Programlarında Tasarıyoruz:

Kusursuz tasarımlarla üretimde ve kullanımda çıkabilecek hataların önüne geçiyoruz.

2

Yanmaz Alev Almaz Plastik Hammaddede:

Maliyetli fakat en kaliteli plastik malzemedir. İlk 10's'lik yanma testi sonrasında anında söner ve damlama olmaz.

3

Dayanıklı Çelik Vida:

Oksitlenme ve korozyona karşı Zn+Cr+μ3 çelik vida alaşımı ile kuvvetlendirilmiş vidalarımız tornavida etkisine karşı dayanıklıdır, paslanmaz ve dişleri her zaman sağlamdır.

4

Cu, Ni Elementleri İçeren Özel Alaşım:

Kaplama; karelere yüksek mukavemet, güvenli bağlantı ve güvenli kullanım özelliği sağlamaktadır. Ayrıca kareler asansörlü sistemi ile sağlam tutuş ve pratik kullanım sağlar.

5

Gümüş Kaplama Pirinç Kontak:

Yüksek akımlara dayanıklılık, lehim almaya uygunluk ve yüksek iletkenlik sağlar. İğne ve kontak lama şeritten kesilir. Pirinç maliyetli fakat en kaliteli sonucu açığa çıkaran bir hammaddedir.

6

Özel Kilitleme Sistemi:

Özel tasarım kilitleme sistemi ile diş ve erkek kısım birbirine kenetlenir.

7

Yüksek İletkenlik:

2x0,98mm² kontak-igne temas noktası, tatlı-sıvı geçme ve gümüş kaplama ile yüksek iletkenlik sağlamaktadır.

8



İÇİNDEKİLER

SOKETLİ BASKILI DEVRE KLEMENSİ	1-14
MODÜLER BASKILI DEVRE KLEMENS	15-17
VIDASIZ KLEMENS SERİSİ	17
SMD KLEMENS SERİSİ	18
KART YUVASI SERİSİ	19
DİSTANS SERİSİ	20-21
PANO TERMOSTAT SERİSİ	22
TAMAMLAYICI ÜRÜNLER	23
ÖZEL TASARIM ÜRÜNLER	24-25

SOKETLİ BASKILI DEVRE KLEMENSİ



3,81mm Dişi

PIN	ÜRETİM KODU	SİPARİŞ NO.						ADET	BİRİM FİYAT
		MAVİ	YEŞİL	TURUNCU	SİYAH	GRI	KIRMIZI		
2	SBDK 3,81-D/2	10.011	11.011	12.011	13.011	14.011	15.011	200	0,2664 \$
3	SBDK 3,81-D/3	10.013	11.013	12.013	13.013	14.013	15.013	200	0,3996 \$
4	SBDK 3,81-D/4	10.015	11.015	12.015	13.015	14.015	15.015	200	0,5328 \$
5	SBDK 3,81-D/5	10.017	11.017	12.017	13.017	14.017	15.017	200	0,6660 \$
6	SBDK 3,81-D/6	10.019	11.019	12.019	13.019	14.019	15.019	200	0,7992 \$
7	SBDK 3,81-D/7	10.021	11.021	12.021	13.021	14.021	15.021	200	0,9324 \$
8	SBDK 3,81-D/8	10.023	11.023	12.023	13.023	14.023	15.023	200	1,0656 \$
12	SBDK 3,81-D/12	10.025	11.025	12.025	13.025	14.025	15.025	100	1,5984 \$
16	SBDK 3,81-D/16	10.027	11.027	12.027	13.027	14.027	15.027	100	2,1312 \$

11,000-sipariş no.lu ürünler stokta bulunur. Diğer ürünler için stok bilgisi alınır.

KOMBİNE ÜRÜNLER



- SBDK3,81-E1
- SBDK 3,81-E2
- SKBK 3,81-KB
- Aşağı bakınız.
- Sayfa 2'ye bakınız.
- Sayfa 2'ye bakınız.

3,81mm ERKEK 90°

PIN	ÜRETİM KODU	SİPARİŞ NO.						ADET	BİRİM FİYAT
		MAVİ	YEŞİL	TURUNCU	SİYAH	GRI	KIRMIZI		
2	SBDK 3,81-E1/2	10.050	11.050	12.050	13.050	14.050	15.050	200	0,0974 \$
3	SBDK 3,81-E1/3	10.052	11.052	12.052	13.052	14.052	15.052	200	0,1461 \$
4	SBDK 3,81-E1/4	10.054	11.054	12.054	13.054	14.054	15.054	200	0,1948 \$
5	SBDK 3,81-E1/5	10.056	11.056	12.056	13.056	14.056	15.056	200	0,2435 \$
6	SBDK 3,81-E1/6	10.058	11.058	12.058	13.058	14.058	15.058	200	0,2922 \$
7	SBDK 3,81-E1/7	10.060	11.060	12.060	13.060	14.060	15.060	200	0,3409 \$
8	SBDK 3,81-E1/8	10.062	11.062	12.062	13.062	14.062	15.062	200	0,3896 \$
12	SBDK 3,81-E1/12	10.064	11.064	12.064	13.064	14.064	15.064	100	0,5357 \$
16	SBDK 3,81-E1/16	10.066	11.066	12.066	13.066	14.066	15.066	100	0,7305 \$

11,000-sipariş no.lu ürünler stokta bulunur. Diğer ürünler için stok bilgisi alınır.

KOMBİNE ÜRÜN



- SBDK 3,81-D
- Yukarı bakınız.

SOKETLİ BASKILI DEVRE KLEMENSİ



3,81mm ERKEK 180°

PIN	ÜRETİM KODU	SİPARİŞ NO.						ADET	BİRİM FİYAT
		MAVİ	YEŞİL	TURUNCU	SİYAH	GRI	KIRMIZI		
2	SBDK 3,81-E2/2	10.100	11.100	12.100	13.100	14.100	15.100	200	0,0974 \$
3	SBDK 3,81-E2/3	10.103	11.103	12.103	13.103	14.103	15.103	200	0,1461 \$
4	SBDK 3,81-E2/4	10.106	11.106	12.106	13.106	14.106	15.106	200	0,1948 \$
5	SBDK 3,81-E2/5	10.109	11.109	12.109	13.109	14.109	15.109	200	0,2435 \$
6	SBDK 3,81-E2/6	10.112	11.112	12.112	13.112	14.112	15.112	200	0,2922 \$
7	SBDK 3,81-E2/7	10.115	11.115	12.115	13.115	14.115	15.115	200	0,3409 \$
8	SBDK 3,81-E2/8	10.118	11.118	12.118	13.118	14.118	15.118	200	0,3896 \$
12	SBDK 3,81-E2/12	10.121	11.121	12.121	13.121	14.121	15.121	100	0,5357 \$
16	SBDK 3,81-E2/16	10.124	11.124	12.124	13.124	14.124	15.124	100	0,7305 \$

11,000-sipariş no.lu ürünler stokta bulunur. Diğer ürünler için stok bilgisi alınız.

KOMBİNE ÜRÜN



- SBDK 3,81-D
- Sayfa 1'e bakınız.

3,81mm KABLO BİRLEŞTİRİCİ ERKEK

PIN	ÜRETİM KODU	SİPARİŞ NO.		ADET	BİRİM FİYAT
		MAVİ	YEŞİL		
2	SKBK 3,81-E/2	10.151	11.151	200	0,3450 \$
3	SKBK 3,81-E/3	10.153	11.153	200	0,5175 \$
4	SKBK 3,81-E/4	10.155	11.155	200	0,6900 \$
5	SKBK 3,81-E/5	10.157	11.157	200	0,8625 \$
6	SKBK 3,81-E/6	10.159	11.159	200	1,0350 \$
7	SKBK 3,81-E/7	10.161	11.161	200	1,2075 \$
8	SKBK 3,81-E/8	10.163	11.163	200	1,3800 \$



11,000-sipariş no.lu ürünler stokta bulunur. Diğer ürünler için stok bilgisi alınız.

KOMBİNE ÜRÜNLER

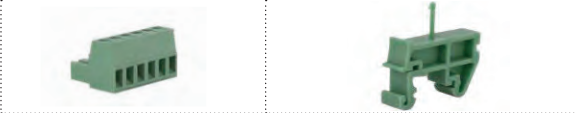

- SBDK 3,81-D
- SKBK 3,81-E
- DIS 3,81/KB
- Sayfa 20'ye bakınız.

SOKETLİ BASKILI DEVRE KLEMENSİ

5,08mm Dişi

PIN	ÜRETİM KODU	SİPARİŞ NO.						ADET	BİRİM FİYAT
		MAVİ	YEŞİL	TURUNCU	SİYAH	GRI	KIRMIZI		
2	SBDK 5,08-D/2	10.202	11.202	12.202	13.202	14.202	15.202	200	0,2364 \$
3	SBDK 5,08-D/3	10.203	11.203	12.203	13.203	14.203	15.203	100	0,3546 \$
4	SBDK 5,08-D/4	10.204	11.204	12.204	13.204	14.204	15.204	100	0,4720 \$
5	SBDK 5,08-D/5	10.205	11.205	12.205	13.205	14.205	15.205	100	0,5910 \$
6	SBDK 5,08-D/6	10.206	11.206	12.206	13.206	14.206	15.206	100	0,7092 \$
7	SBDK 5,08-D/7	10.207	11.207	12.207	13.207	14.207	15.207	100	0,8274 \$
8	SBDK 5,08-D/8	10.208	11.208	12.208	13.208	14.208	15.208	100	0,9456 \$
9	SBDK 5,08-D/9	10.209	11.209	12.209	13.209	14.209	15.209	100	1,0638 \$
10	SBDK 5,08-D/10	10.210	11.210	12.210	13.210	14.210	15.210	50	1,1820 \$
11	SBDK 5,08-D/11	10.211	11.211	12.211	13.211	14.211	15.211	50	1,3002 \$
12	SBDK 5,08-D/12	10.212	11.212	12.212	13.212	14.212	15.212	50	1,4184 \$
13	SBDK 5,08-D/13	10.213	11.213	12.213	13.213	14.213	15.213	50	1,5366 \$
14	SBDK 5,08-D/14	10.214	11.214	12.214	13.214	14.214	15.214	50	1,6548 \$
15	SBDK 5,08-D/15	10.215	11.215	12.215	13.215	14.215	15.215	50	1,7730 \$
16	SBDK 5,08-D/16	10.216	11.216	12.216	13.216	14.216	15.216	50	1,8912 \$
17	SBDK 5,08-D/17	10.217	11.217	12.217	13.217	14.217	15.217	50	2,0094 \$
18	SBDK 5,08-D/18	10.218	11.218	12.218	13.218	14.218	15.218	50	2,1276 \$
19	SBDK 5,08-D/19	10.219	11.219	12.219	13.219	14.219	15.219	25	2,2458 \$
20	SBDK 5,08-D/20	10.220	11.220	12.220	13.220	14.220	15.220	25	2,3640 \$
21	SBDK 5,08-D/21	10.221	11.221	12.221	13.221	14.221	15.221	25	2,4822 \$
22	SBDK 5,08-D/22	10.222	11.222	12.222	13.222	14.222	15.222	25	2,6004 \$
23	SBDK 5,08-D/23	10.223	11.223	12.223	13.223	14.223	15.223	25	2,7186 \$
24	SBDK 5,08-D/24	10.224	11.224	12.224	13.224	14.224	15.224	25	2,8368 \$
25	SBDK 5,08-D/25	10.225	11.225	12.225	13.225	14.225	15.225	25	2,9550 \$



10,000- ve 11,000- sipariş no.lu ürünler stokta bulunur. Diğer ürünler için stok bilgisi alınır.

KOMBİNE ÜRÜNLER



- SBDK 5,08-E1 A
- Sayfa 5'e bakınız.



- SBDK 5,08-E2 A
- Sayfa 6'ya bakınız.



- SBDK 5,08-E1
- Sayfa 7'ye bakınız.



- SBDK 5,08-E2
- Sayfa 7'ye bakınız.



- SBDK 5,08-KE1
- Sayfa 8'e bakınız.



- SBDK 5,08-KE2
- Sayfa 8'e bakınız.



- SKBK 5,08-KB
- Sayfa 10'a bakınız.



- SKBKE 5,08-KB
- Sayfa 8'e bakınız.



- RTKSK 5,08
- Sayfa 9'a bakınız.

SOKETLİ BASKILI DEVRE KLEMENSİ



5,08mm DİK DİŞİ									
PIN	ÜRETİM KODU	SİPARİŞ NO.						ADET	BİRİM FİYAT
		MAVİ	YEŞİL	TURUNCU	SİYAH	GRI	KIRMIZI		
2	SBDK 5,08-DD/2	10.252	11.252	12.252	13.252	14.252	15.252	200	0,3028 \$
3	SBDK 5,08-DD/3	10.253	11.253	12.253	13.253	14.253	15.253	100	0,4542 \$
4	SBDK 5,08-DD/4	10.254	11.254	12.254	13.254	14.254	15.254	100	0,6056 \$
5	SBDK 5,08-DD/5	10.255	11.255	12.255	13.255	14.255	15.255	100	0,7570 \$
6	SBDK 5,08-DD/6	10.256	11.256	12.256	13.256	14.256	15.256	100	0,9084 \$
7	SBDK 5,08-DD/7	10.257	11.257	12.257	13.257	14.257	15.257	100	1,0598 \$
8	SBDK 5,08-DD/8	10.258	11.258	12.258	13.258	14.258	15.258	100	1,2112 \$
9	SBDK 5,08-DD/9	10.259	11.259	12.259	13.259	14.259	15.259	100	1,3626 \$
10	SBDK 5,08-DD/10	10.260	11.260	12.260	13.260	14.260	15.260	50	1,5140 \$
11	SBDK 5,08-DD/11	10.261	11.261	12.261	13.261	14.261	15.261	50	1,6654 \$
12	SBDK 5,08-DD/12	10.262	11.262	12.262	13.262	14.262	15.262	50	1,8168 \$

10,000- ve 11,000- sipariş no.lu ürünler stokta bulunur. Diğer ürünler için stok bilgisi alınız.

KOMBİNE ÜRÜNLER



- SBDK 5,08-E2 A
- Sayfa 6'ya bakınız.



- SBDK 5,08-E2
- Sayfa 7'ye bakınız.



- SBDK 5,08-KE2
- Sayfa 8'e bakınız.

SOKETLİ BASKILI DEVRE KLEMENSİ

5,08mm ERKEK 90° AÇIK

PIN	ÜRETİM KODU	SİPARİŞ NO.						ADET	BİRİM FİYAT
		MAVİ	YEŞİL	TURUNCU	SİYAH	GRI	KIRMIZI		
2	SBDK 5,08-E1A/2	10.302	11.302	12.302	13.302	14.302	15.302	200	0,0902 \$
3	SBDK 5,08-E1A/3	10.303	11.303	12.303	13.303	14.303	15.303	100	0,1353 \$
4	SBDK 5,08-E1A/4	10.304	11.304	12.304	13.304	14.304	15.304	100	0,1804 \$
5	SBDK 5,08-E1A/5	10.305	11.305	12.305	13.305	14.305	15.305	100	0,2255 \$
6	SBDK 5,08-E1A/6	10.306	11.306	12.306	13.306	14.306	15.306	100	0,2706 \$
7	SBDK 5,08-E1A/7	10.307	11.307	12.307	13.307	14.307	15.307	100	0,3157 \$
8	SBDK 5,08-E1A/8	10.308	11.308	12.308	13.308	14.308	15.308	100	0,3608 \$
9	SBDK 5,08-E1A/9	10.309	11.309	12.309	13.309	14.309	15.309	100	0,4059 \$
10	SBDK 5,08-E1A/10	10.310	11.310	12.310	13.310	14.310	15.310	50	0,4510 \$
11	SBDK 5,08-E1A/11	10.311	11.311	12.311	13.311	14.311	15.311	50	0,4961 \$
12	SBDK 5,08-E1A/12	10.312	11.312	12.312	13.312	14.312	15.312	50	0,5412 \$
13	SBDK 5,08-E1A/13	10.313	11.313	12.313	13.313	14.313	15.313	50	0,5863 \$
14	SBDK 5,08-E1A/14	10.314	11.314	12.314	13.314	14.314	15.314	50	0,6314 \$
15	SBDK 5,08-E1A/15	10.315	11.315	12.315	13.315	14.315	15.315	50	0,6765 \$
16	SBDK 5,08-E1A/16	10.316	11.316	12.316	13.316	14.316	15.316	50	0,7216 \$
17	SBDK 5,08-E1A/17	10.317	11.317	12.317	13.317	14.317	15.317	50	0,7667 \$
18	SBDK 5,08-E1A/18	10.318	11.318	12.318	13.318	14.318	15.318	50	0,8118 \$
19	SBDK 5,08-E1A/19	10.319	11.319	12.319	13.319	14.319	15.319	25	0,8569 \$
20	SBDK 5,08-E1A/20	10.320	11.320	12.320	13.320	14.320	15.320	25	0,9020 \$
21	SBDK 5,08-E1A/21	10.321	11.321	12.321	13.321	14.321	15.321	25	0,9471 \$
22	SBDK 5,08-E1A/22	10.322	11.322	12.322	13.322	14.322	15.322	25	0,9922 \$
23	SBDK 5,08-E1A/23	10.323	11.323	12.323	13.323	14.323	15.323	25	1,0373 \$
24	SBDK 5,08-E1A/24	10.324	11.324	12.324	13.324	14.324	15.324	25	1,0824 \$
25	SBDK 5,08-E1A/25	10.325	11.325	12.325	13.325	14.325	15.325	25	1,1275 \$

10,000- ve 11,000- sipariş no.lu ürünler stokta bulunur. Diğer ürünler için stok bilgisi alınır.

KOMBİNE ÜRÜN



- SBDK 5,08-D
- Sayfa 3'e bakınız.

SOKETLİ BASKILI DEVRE KLEMENSİ

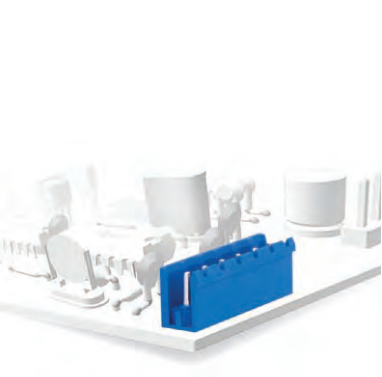

5,08mm ERKEK 180° AÇIK									
PIN	ÜRETİM KODU	SİPARİŞ NO.						ADET	BİRİM FİYAT
		MAVİ	YEŞİL	TURUNCU	SİYAH	GRI	KIRMIZI		
2	SBDK 5,08-E2A/2	10.352	11.352	12.352	13.352	14.352	15.352	200	0,0902 \$
3	SBDK 5,08-E2A/3	10.353	11.353	12.353	13.353	14.353	15.353	100	0,1353 \$
4	SBDK 5,08-E2A/4	10.354	11.354	12.354	13.354	14.354	15.354	100	0,1804 \$
5	SBDK 5,08-E2A/5	10.355	11.355	12.355	13.355	14.355	15.355	100	0,2255 \$
6	SBDK 5,08-E2A/6	10.356	11.356	12.356	13.356	14.356	15.356	100	0,2706 \$
7	SBDK 5,08-E2A/7	10.357	11.357	12.357	13.357	14.357	15.357	100	0,3157 \$
8	SBDK 5,08-E2A/8	10.358	11.358	12.358	13.358	14.358	15.358	100	0,3608 \$
9	SBDK 5,08-E2A/9	10.359	11.359	12.359	13.359	14.359	15.359	100	0,4059 \$
10	SBDK 5,08-E2A/10	10.360	11.360	12.360	13.360	14.360	15.360	50	0,4510 \$
11	SBDK 5,08-E2A/11	10.361	11.361	12.361	13.361	14.361	15.361	50	0,4961 \$
12	SBDK 5,08-E2A/12	10.362	11.362	12.362	13.362	14.362	15.362	50	0,5412 \$
13	SBDK 5,08-E2A/13	10.363	11.363	12.363	13.363	14.363	15.363	50	0,5863 \$
14	SBDK 5,08-E2A/14	10.364	11.364	12.364	13.364	14.364	15.364	50	0,6314 \$
15	SBDK 5,08-E2A/15	10.365	11.365	12.365	13.365	14.365	15.365	50	0,6765 \$
16	SBDK 5,08-E2A/16	10.366	11.366	12.366	13.366	14.366	15.366	50	0,7216 \$
17	SBDK 5,08-E2A/17	10.367	11.367	12.367	13.367	14.367	15.367	50	0,7667 \$
18	SBDK 5,08-E2A/18	10.368	11.368	12.368	13.368	14.368	15.368	50	0,8118 \$
19	SBDK 5,08-E2A/19	10.369	11.369	12.369	13.369	14.369	15.369	25	0,8569 \$
20	SBDK 5,08-E2A/20	10.370	11.370	12.370	13.370	14.370	15.370	25	0,9020 \$
21	SBDK 5,08-E2A/21	10.371	11.371	12.371	13.371	14.371	15.371	25	0,9471 \$
22	SBDK 5,08-E2A/22	10.372	11.372	12.372	13.372	14.372	15.372	25	0,9922 \$
23	SBDK 5,08-E2A/23	10.373	11.373	12.373	13.373	14.373	15.373	25	1,0373 \$
24	SBDK 5,08-E2A/24	10.374	11.374	12.374	13.374	14.374	15.374	25	1,0824 \$
25	SBDK 5,08-E2A/25	10.375	11.375	12.375	13.375	14.375	15.375	25	1,1275 \$

10,000- ve 11,000- sipariş no.lu ürünler stokta bulunur. Diğer ürünler için stok bilgisi alınız.

KOMBİNE ÜRÜNLER



- SBDK 5,08-D
- Sayfa 3'e bakınız.
- SBDK 5,08-DD
- Sayfa 4'e bakınız.

SOKETLİ BASKILI DEVRE KLEMENSİ

5,08mm ERKEK 90° KAPALI

PIN	ÜRETİM KODU	SİPARİŞ NO.						ADET	BİRİM FİYAT
		MAVİ	YESİL	TURUNCU	SİYAH	GRI	KIRMIZI		
2	SBDK 5,08-E1/2	10.402	11.402	12.402	13.402	14.402	15.402	200	0,1086 \$
3	SBDK 5,08-E1/3	10.403	11.403	12.403	13.403	14.403	15.403	100	0,1629 \$
4	SBDK 5,08-E1/4	10.404	11.404	12.404	13.404	14.404	15.404	100	0,2172 \$
5	SBDK 5,08-E1/5	10.405	11.405	12.405	13.405	14.405	15.405	100	0,2715 \$
6	SBDK 5,08-E1/6	10.406	11.406	12.406	13.406	14.406	15.406	100	0,3258 \$
7	SBDK 5,08-E1/7	10.407	11.407	12.407	13.407	14.407	15.407	100	0,3801 \$
8	SBDK 5,08-E1/8	10.408	11.408	12.408	13.408	14.408	15.408	100	0,4344 \$
9	SBDK 5,08-E1/9	10.409	11.409	12.409	13.409	14.409	15.409	100	0,4887 \$
10	SBDK 5,08-E1/10	10.410	11.410	12.410	13.410	14.410	15.410	50	0,5430 \$
11	SBDK 5,08-E1/11	10.411	11.411	12.411	13.411	14.411	15.411	50	0,5973 \$
12	SBDK 5,08-E1/12	10.412	11.412	12.412	13.412	14.412	15.412	50	0,6516 \$
25	SBDK 5,08-E1/25	10.425	11.425	12.425	13.425	14.425	15.425	25	1,3575 \$

10,000- ve 11,000- sipariş no.lu ürünler stokta bulunur. Diğer ürünler için stok bilgisi alınır.

KOMBİNE ÜRÜN



- SBDK 5,08-D
- Sayfa 3'e bakınız.

5,08mm ERKEK 180° KAPALI

PIN	ÜRETİM KODU	SİPARİŞ NO.						ADET	BİRİM FİYAT
		MAVİ	YESİL	TURUNCU	SİYAH	GRI	KIRMIZI		
2	SBDK 5,08-E2/2	10.452	11.452	12.452	13.452	14.452	15.452	200	0,1086 \$
3	SBDK 5,08-E2/3	10.453	11.453	12.453	13.453	14.453	15.453	100	0,1629 \$
4	SBDK 5,08-E2/4	10.454	11.454	12.454	13.454	14.454	15.454	100	0,2172 \$
5	SBDK 5,08-E2/5	10.455	11.455	12.455	13.455	14.455	15.455	100	0,2715 \$
6	SBDK 5,08-E2/6	10.456	11.456	12.456	13.456	14.456	15.456	100	0,3258 \$
7	SBDK 5,08-E2/7	10.457	11.457	12.457	13.457	14.457	15.457	100	0,3801 \$
8	SBDK 5,08-E2/8	10.458	11.458	12.458	13.458	14.458	15.458	100	0,4344 \$
9	SBDK 5,08-E2/9	10.459	11.459	12.459	13.459	14.459	15.459	100	0,4887 \$
10	SBDK 5,08-E2/10	10.460	11.460	12.460	13.460	14.460	15.460	50	0,5430 \$
11	SBDK 5,08-E2/11	10.461	11.461	12.461	13.461	14.461	15.461	50	0,5973 \$
12	SBDK 5,08-E2/12	10.462	11.462	12.462	13.462	14.462	15.462	50	0,6516 \$
25	SBDK 5,08-E2/25	10.475	11.475	12.475	13.475	14.475	15.475	25	1,3575 \$

10,000- ve 11,000- sipariş no.lu ürünler stokta bulunur. Diğer ürünler için stok bilgisi alınır.

KOMBİNE ÜRÜNLER



- SBDK 5,08-D
- SBDK 5,08-DD
- Sayfa 3'e bakınız.
- Sayfa 4'e bakınız.

SOKETLİ BASKILI DEVRE KLEMENSİ



5,08mm KATLI ERKEK 90°

PIN	ÜRETİM KODU	SİPARİŞ NO.						ADET	BİRİM FİYAT
		MAVİ	YEŞİL	TURUNCU	SIYAH	GRI	KIRMIZI		
2x2	SBDK 5,08 KE1/2	10.500	11.500	12.500	13.500	14.500	15.500	100	0,2692 \$
2x3	SBDK 5,08 KE1/3	10.525	11.525	12.525	13.525	14.525	15.525	50	0,4038 \$

10,000- ve 11,000- sipariş no.lu ürünler stokta bulunur. Diğer ürünler için stok bilgisi alınır.

KOMBİNE ÜRÜN



- SBDK 5,08-D
- Sayfa 3'e bakınız.



5,08mm KATLI ERKEK 180°

PIN	ÜRETİM KODU	SİPARİŞ NO.						ADET	BİRİM FİYAT
		MAVİ	YEŞİL	TURUNCU	SIYAH	GRI	KIRMIZI		
2x2	SBDK 5,08 KE2/2	10.550	11.550	12.550	13.550	14.550	15.550	100	0,2692 \$
2x3	SBDK 5,08 KE2/3	10.575	11.575	12.575	13.575	14.575	15.575	50	0,4038 \$

10,000- ve 11,000- sipariş no.lu ürünler stokta bulunur. Diğer ürünler için stok bilgisi alınır.

KOMBİNE ÜRÜNLER



- SBDK 5,08-D
- SBDK 5,08-DD
- Sayfa 3'e bakınız.
- Sayfa 4'e bakınız.

5,08mm SOKET KABLO BİRLEŞTİRİCİ KATLI ERKEK

PIN	ÜRETİM KODU	SİPARİŞ NO.						ADET	BİRİM FİYAT
		MAVİ	YEŞİL	TURUNCU	SIYAH	GRI	KIRMIZI		
2	SKBKE 5,08-KB/2x2	10.652	11.652	12.652	13.652	14.652	15.652	50	0,6414 \$
3	SKBKE 5,08-KB/2x3	10.653	11.653	12.653	13.653	14.653	15.653	50	0,9621 \$
4	SKBKE 5,08-KB/2x4	10.654	11.654	12.654	13.654	14.654	15.654	40	1,2828 \$
5	SKBKE 5,08-KB/2x5	10.655	11.655	12.655	13.655	14.655	15.655	40	1,6035 \$
6	SKBKE 5,08-KB/2x6	10.656	11.656	12.656	13.656	14.656	15.656	40	1,9242 \$
7	SKBKE 5,08-KB/2x7	10.657	11.657	12.657	13.657	14.657	15.657	25	2,2449 \$
8	SKBKE 5,08-KB/2x8	10.658	11.658	12.658	13.658	14.658	15.658	25	2,5656 \$
9	SKBKE 5,08-KB/2x9	10.659	11.659	12.659	13.659	14.659	15.659	25	2,8863 \$
10	SKBKE 5,08-KB/2x10	10.660	11.660	12.660	13.660	14.660	15.660	20	3,2070 \$
11	SKBKE 5,08-KB/2x11	10.661	11.661	12.661	13.661	14.661	15.661	20	3,5277 \$
12	SKBKE 5,08-KB/2x12	10.662	11.662	12.662	13.662	14.662	15.662	20	3,8484 \$

10,000- ve 11,000- sipariş no.lu ürünler stokta bulunur. Diğer ürünler için stok bilgisi alınır.

KOMBİNE ÜRÜNLER



- SBDK 5,08-D
- DIS 5,08/KB
- Sayfa 3'e bakınız.
- Sayfa 20'ye bakınız.



SOKETLİ BASKILI DEVRE KLEMENSİ



5,08mm RAY TİPİ SOKET KLEMENS

PIN	ÜRETİM KODU	SİPARİŞ NO.						ADET	BİRİM FİYAT
		MAVİ	YEŞİL	TURUNCU	SİYAH	GRI	KIRMIZI		
2	RTKSK 5,08-2x2	10.672	11.672	12.672	13.672	14.672	15.672	50	1,8930 \$
3	RTKSK 5,08-2x3	10.673	11.673	12.673	13.673	14.673	15.673	50	2,8395 \$
4	RTKSK 5,08-2x4	10.674	11.674	12.674	13.674	14.674	15.674	40	3,7860 \$
5	RTKSK 5,08-2x5	10.675	11.675	12.675	13.675	14.675	15.675	40	4,7325 \$
6	RTKSK 5,08-2x6	10.676	11.676	12.676	13.676	14.676	15.676	40	5,6790 \$
7	RTKSK 5,08-2x7	10.677	11.677	12.677	13.677	14.677	15.677	25	6,6255 \$
8	RTKSK 5,08-2x8	10.678	11.678	12.678	13.678	14.678	15.678	25	7,5720 \$
9	RTKSK 5,08-2x9	10.679	11.679	12.679	13.679	14.679	15.679	25	8,5185 \$
10	RTKSK 5,08-2x10	10.680	11.680	12.680	13.680	14.680	15.680	20	9,4650 \$
11	RTKSK 5,08-2x11	10.681	11.681	12.681	13.681	14.681	15.681	20	10,4115 \$
12	RTKSK 5,08-2x12	10.682	11.682	12.682	13.682	14.682	15.682	20	11,3580 \$

10,000- ve 11,000- sipariş no.lu ürünler stokta bulunur. Diğer ürünler için stok bilgisi alınız.

KOMBİNE ÜRÜN



- SBDK 5,08-D
- Sayfa 3'e bakınız.

2,5mm ray
klemens yerine
kullanılabilir

SOKET KABLO BİRLEŞTİRİCİ KLEMENS



5,08mm KABLO BİRLEŞTİRİCİ ERKEK

PIN	ÜRETİM KODU	SİPARİŞ NO.		ADET	BİRİM FİYAT
		MAVİ	YEŞİL		
2	SKBK 5,08-KB/2	10.602	11.602	200	0,3536 \$
3	SKBK 5,08-KB/3	10.603	11.603	100	0,5304 \$
4	SKBK 5,08-KB/4	10.604	11.604	100	0,7072 \$
5	SKBK 5,08-KB/5	10.605	11.605	100	0,8840 \$
6	SKBK 5,08-KB/6	10.606	11.606	100	1,0608 \$
7	SKBK 5,08-KB/7	10.607	11.607	100	1,2376 \$
8	SKBK 5,08-KB/8	10.608	11.608	100	1,4144 \$
9	SKBK 5,08-KB/9	10.609	11.609	100	1,5912 \$
10	SKBK 5,08-KB/10	10.610	11.610	50	1,7680 \$
11	SKBK 5,08-KB/11	10.611	11.611	50	1,9448 \$
12	SKBK 5,08-KB/12	10.612	11.612	50	2,1216 \$
13	SKBK 5,08-KB/13	10.613	11.613	50	2,2984 \$
14	SKBK 5,08-KB/14	10.614	11.614	50	2,4752 \$
15	SKBK 5,08-KB/15	10.615	11.615	50	2,6520 \$
16	SKBK 5,08-KB/16	10.616	11.616	50	2,8288 \$
17	SKBK 5,08-KB/17	10.617	11.617	50	3,0056 \$
18	SKBK 5,08-KB/18	10.618	11.618	50	3,1824 \$
19	SKBK 5,08-KB/19	10.619	11.619	25	3,3592 \$
20	SKBK 5,08-KB/20	10.620	11.620	25	3,5360 \$
21	SKBK 5,08-KB/21	10.621	11.621	25	3,7128 \$
22	SKBK 5,08-KB/22	10.622	11.622	25	3,8896 \$
23	SKBK 5,08-KB/23	10.623	11.623	25	4,0664 \$
24	SKBK 5,08-KB/24	10.624	11.624	25	4,2432 \$
25	SKBK 5,08-KB/25	10.625	11.625	25	4,4200 \$

10,000-sipariş no.lu ürünler stokta bulunur. Diğer ürünler için stok bilgisi alınız.

KOMBİNE ÜRÜNLER



- SBDK 5,08-D
- Sayfa 3'e bakınız.



- DIS 5,08/KB
- Sayfa 20'ye bakınız.



- SBDK 5,08-DD
- Sayfa 4'e bakınız.

SOKETLİ BASKILI DEVRE KLEMENSİ

7,62mm Dişi

PIN	ÜRETİM KODU	SİPARİŞ NO.						ADET	BİRİM FİYAT
		MAVİ	YEŞİL	TURUNCU	SİYAH	GRI	KIRMIZI		
2	SBDK 7,62-D/2	10.702	11.702	12.702	13.702	14.702	15.702	200	0,3210 \$
3	SBDK 7,62-D/3	10.703	11.703	12.703	13.703	14.703	15.703	100	0,4815 \$
4	SBDK 7,62-D/4	10.704	11.704	12.704	13.704	14.704	15.704	100	0,6420 \$
5	SBDK 7,62-D/5	10.705	11.705	12.705	13.705	14.705	15.705	100	0,8025 \$
6	SBDK 7,62-D/6	10.706	11.706	12.706	13.706	14.706	15.706	100	0,9630 \$
7	SBDK 7,62-D/7	10.707	11.707	12.707	13.707	14.707	15.707	50	1,1235 \$
8	SBDK 7,62-D/8	10.708	11.708	12.708	13.708	14.708	15.708	50	1,2840 \$
9	SBDK 7,62-D/9	10.709	11.709	12.709	13.709	14.709	15.709	50	1,4445 \$
10	SBDK 7,62-D/10	10.710	11.710	12.710	13.710	14.710	15.710	50	1,6050 \$
11	SBDK 7,62-D/11	10.711	11.711	12.711	13.711	14.711	15.711	50	1,7655 \$
12	SBDK 7,62-D/12	10.712	11.712	12.712	13.712	14.712	15.712	50	1,9260 \$

10,000- ve 11,000- sipariş no.lu ürünler stokta bulunur. Diğer ürünler için stok bilgisi alınır.

KOMBİNE ÜRÜNLER



- SBDK 7,62-E1
- Sayfa 12'ye bakınız.



- SBDK 7,62-E2
- Sayfa 12'ye bakınız.



- SBDK 7,62-KE1
- Sayfa 13'e bakınız.



- SBDK 7,62-KE2
- Sayfa 13'e bakınız.



- SBDK 7,62-KB
- Sayfa 14'e bakınız.

7,62mm Diğ Dişi

PIN	ÜRETİM KODU	SİPARİŞ NO.						ADET	BİRİM FİYAT
		MAVİ	YEŞİL	TURUNCU	SİYAH	GRI	KIRMIZI		
2	SBDK 7,62-DD/2	10.752	11.752	12.752	13.752	14.752	15.752	200	0,3752 \$
3	SBDK 7,62-DD/3	10.753	11.753	12.753	13.753	14.753	15.753	100	0,5628 \$
4	SBDK 7,62-DD/4	10.754	11.754	12.754	13.754	14.754	15.754	100	0,7504 \$
5	SBDK 7,62-DD/5	10.755	11.755	12.755	13.755	14.755	15.755	100	0,9380 \$
6	SBDK 7,62-DD/6	10.756	11.756	12.756	13.756	14.756	15.756	100	1,1256 \$
7	SBDK 7,62-DD/7	10.757	11.757	12.757	13.757	14.757	15.757	50	1,3132 \$
8	SBDK 7,62-DD/8	10.758	11.758	12.758	13.758	14.758	15.758	50	1,5008 \$
9	SBDK 7,62-DD/9	10.759	11.759	12.759	13.759	14.759	15.759	50	1,6884 \$
10	SBDK 7,62-DD/10	10.760	11.760	12.760	13.760	14.760	15.760	50	1,8760 \$
11	SBDK 7,62-DD/11	10.761	11.761	12.761	13.761	14.761	15.761	50	2,0636 \$
12	SBDK 7,62-DD/12	10.762	11.762	12.762	13.762	14.762	15.762	50	2,2512 \$

10,000- ve 11,000- sipariş no.lu ürünler stokta bulunur. Diğer ürünler için stok bilgisi alınır.

KOMBİNE ÜRÜNLER



- SBDK 7,62-E2
- Sayfa 12'ye bakınız.



- SBDK 7,62-KE2
- Sayfa 13'e bakınız.



- SBDK 7,62-KB
- Sayfa 14'e bakınız.



SOKETLİ BASKILI DEVRE KLEMENSİ



7,62mm ERKEK 90°

PIN	ÜRETİM KODU	SİPARİŞ NO.						ADET	BİRİM FİYAT
		MAVİ	YESİL	TURUNCU	SİYAH	GRI	KIRMIZI		
2	SBDK 7,62-E1/2	10.802	11.802	12.802	13.802	14.802	15.802	200	0,1216 \$
3	SBDK 7,62-E1/3	10.803	11.803	12.803	13.803	14.803	15.803	100	0,1824 \$
4	SBDK 7,62-E1/4	10.804	11.804	12.804	13.804	14.804	15.804	100	0,2432 \$
5	SBDK 7,62-E1/5	10.805	11.805	12.805	13.805	14.805	15.805	100	0,3040 \$
6	SBDK 7,62-E1/6	10.806	11.806	12.806	13.806	14.806	15.806	100	0,3648 \$
7	SBDK 7,62-E1/7	10.807	11.807	12.807	13.807	14.807	15.807	50	0,4256 \$
8	SBDK 7,62-E1/8	10.808	11.808	12.808	13.808	14.808	15.808	50	0,4864 \$
9	SBDK 7,62-E1/9	10.809	11.809	12.809	13.809	14.809	15.809	50	0,5472 \$
10	SBDK 7,62-E1/10	10.810	11.810	12.810	13.810	14.810	15.810	50	0,6080 \$
11	SBDK 7,62-E1/11	10.811	11.811	12.811	13.811	14.811	15.811	50	0,6688 \$
12	SBDK 7,62-E1/12	10.812	11.812	12.812	13.812	14.812	15.812	50	0,7296 \$

10,000- ve 11,000- sipariş no.lu ürünler stokta bulunur. Diğer ürünler için stok bilgisi alınır.

KOMBİNE ÜRÜN



- SBDK 7,62-D
- Sayfa 11'e bakınız.

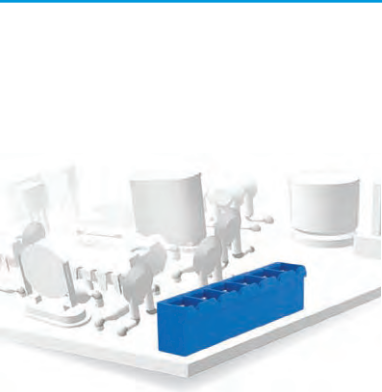

7,62mm ERKEK 180°

PIN	ÜRETİM KODU	SİPARİŞ NO.						ADET	BİRİM FİYAT
		MAVİ	YESİL	TURUNCU	SİYAH	GRI	KIRMIZI		
2	SBDK 7,62-E2/2	10.852	11.852	12.852	13.852	14.852	15.852	200	0,1216 \$
3	SBDK 7,62-E2/3	10.853	11.853	12.853	13.853	14.853	15.853	100	0,1824 \$
4	SBDK 7,62-E2/4	10.854	11.854	12.854	13.854	14.854	15.854	100	0,2432 \$
5	SBDK 7,62-E2/5	10.855	11.855	12.855	13.855	14.855	15.855	100	0,3040 \$
6	SBDK 7,62-E2/6	10.856	11.856	12.856	13.856	14.856	15.856	100	0,3648 \$
7	SBDK 7,62-E2/7	10.857	11.857	12.857	13.857	14.857	15.857	50	0,4256 \$
8	SBDK 7,62-E2/8	10.858	11.858	12.858	13.858	14.858	15.858	50	0,4864 \$
9	SBDK 7,62-E2/9	10.859	11.859	12.859	13.859	14.859	15.859	50	0,5472 \$
10	SBDK 7,62-E2/10	10.860	11.860	12.860	13.860	14.860	15.860	50	0,6080 \$
11	SBDK 7,62-E2/11	10.861	11.861	12.861	13.861	14.861	15.861	50	0,6688 \$
12	SBDK 7,62-E2/12	10.862	11.862	12.862	13.862	14.862	15.862	50	0,7296 \$

10,000- ve 11,000- sipariş no.lu ürünler stokta bulunur. Diğer ürünler için stok bilgisi alınır.

KOMBİNE ÜRÜNLER



- SBDK 7,62-D
- SBDK 7,62-DD
- Sayfa 11'e bakınız.
- Sayfa 11'e bakınız.

SOKETLİ BASKILI DEVRE KLEMENSİ



7,62mm KATLI ERKEK 90°

PIN	ÜRETİM KODU	SİPARİŞ NO.						ADET	BİRİM FİYAT
		MAVİ	YEŞİL	TURUNCU	SİYAH	GRI	KIRMIZI		
2	SBDK 7,62 KE1/2	10.900	11.900	12.900	13.900	14.900	15.900	100	0,3330 \$
3	SBDK 7,62 KE1/3	10.925	11.925	12.925	13.925	14.925	15.925	50	0,4995 \$

10,000- ve 11,000- sipariş no.lu ürünler stokta bulunur. Diğer ürünler için stok bilgisi alınız.

KOMBİNE ÜRÜN



- SBDK 7,62-D
- Sayfa 11'e bakınız.



7,62mm KATLI ERKEK 180°

PIN	ÜRETİM KODU	SİPARİŞ NO.						ADET	BİRİM FİYAT
		MAVİ	YEŞİL	TURUNCU	SİYAH	GRI	KIRMIZI		
2	SBDK 7,62 KE2/2	10.950	11.950	12.950	13.950	14.950	15.950	100	0,3330 \$
3	SBDK 7,62 KE2/3	10.975	11.975	12.975	13.975	14.975	15.975	50	0,4995 \$

10,000- ve 11,000- sipariş no.lu ürünler stokta bulunur. Diğer ürünler için stok bilgisi alınız.

KOMBİNE ÜRÜNLER



- SBDK 7,62-D
- SBDK 7,62-DD
- Sayfa 11'e bakınız.
- Sayfa 11'e bakınız.

SOKETLİ KABLO BİRLEŞTİRİCİ KLEMENSİ



7,62mm KABLO BİRLEŞTİRİCİ ERKEK

PIN	ÜRETİM KODU	SİPARİŞ NO.		ADET	BİRİM FİYAT
		MAVİ	YEŞİL		
2	SKBK 7,62-KB/E	10.902	11.902	200	0,3672 \$
3	SKBK 7,62-KB/E	10.903	11.903	100	0,5508 \$
4	SKBK 7,62-KB/E	10.904	11.904	100	0,7344 \$
5	SKBK 7,62-KB/E	10.905	11.905	100	0,9180 \$
6	SKBK 7,62-KB/E	10.906	11.906	100	1,1016 \$
7	SKBK 7,62-KB/E	10.907	11.907	50	1,2852 \$
8	SKBK 7,62-KB/E	10.908	11.908	50	1,4688 \$
9	SKBK 7,62-KB/E	10.909	11.909	50	1,6524 \$
10	SKBK 7,62-KB/E	10.910	11.910	50	1,8360 \$
11	SKBK 7,62-KB/E	10.911	11.911	50	2,0196 \$
12	SKBK 7,62-KB/E	10.912	11.912	50	2,2032 \$

10.000 sipariş nolu ürünler stokda bulunur. Diğer ürünler için stok bilgisialınız.

KOMBİNE ÜRÜNLER



- SBDK 7,62-D
- Sayfa 11'e bakınız.
- DIS 5,08/KB
- Sayfa 20'ye bakınız.

MODÜLER BASKILI DEVRE KLEMENS

		5,08mm MODÜLER								
ÜRÜN	ÜRETİM KODU	SİPARİŞ NO.						ADET	BİRİM FİYAT	
		MAVİ	YEŞİL	TURUNCU	SIYAH	GRI	KIRMIZI			
	NO:0 2Lİ	MBDK 5,08-0/2	20.100	21.100	22.100	23.100	24.100	25.100	500	0,1040 \$
	NO:0 3LÜ	MBDK 5,08-0/3	20.140	21.140	22.140	23.140	24.140	25.140	500	0,1560 \$
	NO:1 2Lİ	MBDK 5,08-1/2	20.180	21.180	22.180	23.180	24.180	25.180	250	0,1584 \$
	NO:1 3LÜ	MBDK 5,08-1/3	20.220	21.220	22.220	23.220	24.220	25.220	250	0,2376 \$
	NO:1 2Lİ L	MBDK 5,08-1/2L	20.260	21.260	22.260	23.260	24.260	25.260	250	0,1760 \$
	NO:1 3LÜ L	MBDK 5,08-1/3L	20.300	21.300	22.300	23.300	24.300	25.300	250	0,2640 \$
	NO:2 2Lİ	MBDK 5,08-2/2	20.340	21.340	22.340	23.340	24.340	25.340	200	0,3088 \$
	NO:2 3LÜ	MBDK 5,08-2/3	20.380	21.380	22.380	23.380	24.380	25.380	200	0,4632 \$
	NO:2 10LU	MBDK5,08-2/10	20.420	21.420	22.420	23.420	24.420	25.420	50	1,5440 \$

20,000-ve 21,000 sipariş no.lu ürünler stokta bulunur. Diğer ürünler için stok bilgisi alınır.

MODÜLER BASKILI DEVRE KLEMENS



7,62mm MODÜLER

ÜRÜN	ÜRETİM KODU	SİPARİŞ NO.						ADET	BİRİM FİYAT
		MAVİ	YEŞİL	TURUNCU	SİYAH	GRI	KIRMIZI		
NO:2 2Lİ 7,62	MBDK 7,62-2/2	20.460	21.460	22.460	23.460	24.460	25.460	200	0,3310 \$
NO:2 3LÜ 7,62	MBDK 7,62-2/3	20.500	21.500	22.500	23.500	24.500	25.500	200	0,4965 \$

20.000 ve 21.000 sipariş no'lu ürünler stokta bulunur. Diğer ürünler için stok bilgisi alınız.



10,16x10,16mm MODÜLER

ÜRÜN	ÜRETİM KODU	SİPARİŞ NO.						ADET	BİRİM FİYAT
		MAVİ	YEŞİL	TURUNCU	SİYAH	GRI	KIRMIZI		
10,16 TEKLİ	MBDK 10,16-1	20.580	21.580	22.580	23.580	24.580	25.580	100	0,9970 \$
10,16 2Lİ	MBDK 10,16-2	20.590	21.590	22.590	23.590	24.590	25.590	50	1,9940 \$
10,16 3LÜ	MBDK 10,16-3	20.595	21.595	22.595	23.595	24.595	25.595	25	2,9910 \$
10,16 4LÜ	MBDK 10,16-4	20.600	21.600	22.600	23.600	24.600	25.600	25	3,9880 \$
10,16 5Lİ	MBDK 10,16-5	20.605	21.605	22.605	23.605	24.605	25.605	25	4,9850 \$
10,16 6Lİ	MBDK 10,16-6	20.610	21.610	22.610	23.610	24.610	25.610	25	5,9820 \$
2.54 mm ARA PLAKA	MBDK-PY	20.620	21.620	22.620	23.620	24.620	25.620	100	0,0997 \$

20.000 ve 21.000 sipariş no'lu ürünler stokta bulunur. Diğer ürünler için stok bilgisi alınız.



3,81x7,62x15,24mm BASKILI DEVRE GÜÇ KLEMENSİ

ÜRÜN	ÜRETİM KODU	SİPARİŞ NO.						ADET	BİRİM FİYAT
		MAVİ	YEŞİL	TURUNCU	SİYAH	GRI	KIRMIZI		
GÜÇ KLEMENSİ	BDGK-433	20.660	21.660	22.660	23.660	24.660	25.660	10	4,3795 \$

20,000- ve 21,000- sipariş no.lu ürünler stokta bulunur. Diğer ürünler için stok bilgisi alınız.

MODÜLER BASKILI DEVRE KLEMENS



9,52x7,62mm MODÜL

ÜRÜN	ÜRETİM KODU	SİPARİŞ NO.						ADET	BİRİM FİYAT
		MAVİ	YEŞİL	TURUNCU	SİYAH	GRI	KIRMIZI		
9.52 TEKLİ	MBDK 9,52-1	20.540	21.540	22.540	23.540	24.540	25.540	200	0,6440 \$
9.52 2'Lİ	MBDK 9,52-2	20.545	21.545	22.545	23.545	24.545	25.545	100	1,2880 \$
9.52 3'LÜ	MBDK 9,52-3	20.550	21.550	22.550	23.550	24.550	25.550	50	1,9320 \$
9.52 4'LÜ	MBDK 9,52-4	20.555	21.555	22.555	23.555	24.555	25.555	50	2,5760 \$

21.000 sipariş no'lu ürünler stokta bulunur. Diğer ürünler için stok bilgisi alınır.

VİDASIZ KLEMENS SERİSİ







5.08x7.62mm VİDASIZ

PIN	ÜRETİM KODU	SİPARİŞ NO.		ADET	BİRİM FİYAT
		YEŞİL	GRI		
2	VBDK/2	31.120	34.120	200	0,1620 \$
3	VBDK/3	31.160	34.160	100	0,2430 \$
4	VBDK/4	31.200	34.200	100	0,3240 \$
5	VBDK/5	31.240	34.240	100	0,4050 \$
6	VBDK/6	31.280	34.280	100	0,4860 \$
7	VBDK/7	31.320	34.320	100	0,5670 \$
8	VBDK/8	31.360	34.360	100	0,6480 \$
9	VBDK/9	31.400	34.400	100	0,7290 \$
10	VBDK/10	31.440	34.440	50	0,8100 \$
11	VBDK/11	31.480	34.480	50	0,8910 \$
12	VBDK/12	31.520	34.520	50	0,9720 \$

34,000- sipariş no.lu ürünler stokta bulunur. Diğer ürünler için stok bilgisi alınır.

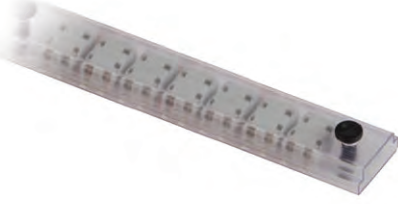
SMD KLEMENS SERİSİ

SMD					
ÜRÜN	ÜRETİM KODU	SİPARİŞ NO	ADET	BİRİM FİYAT	
		NATUREL			
	YAYSIZ	SMD Y/0	49.000	1000	0,2270 \$
	YAYLI - TEK	SMD Y/1	49.100	1000	0,1398 \$
	YAYLI - ÇİFT	SMD Y/2	49.130	1000	0,2098 \$
	YAYSIZ (TÜPLÜ)	SMD Y/T0	49.180	60	0,2573 \$
	YAYLI - TEK (TÜPLÜ)	SMD Y/T1	49.230	108	0,1522 \$
	YAYLI - ÇİFT (TÜPLÜ)	SMD Y/T2	49.280	60	0,2283 \$

KART YUVASI SERİSİ

72mm MODÜL

ÜRÜN	ÜRETİM KODU	SİPARİŞ NO	ADET	BİRİM FİYAT
		YESİL		
MODÜL	KYS MM/72	51.050	50	0,4901 \$
KAPAK	KYS MK/72	51.075	50	0,2863 \$
AYAK	KYS MA/72	51.100	50	0,3578 \$



72mm PROFİL

ÜRÜN	ÜRETİM KODU	SİPARİŞ NO	ADET	BİRİM FİYAT
		YESİL		
PROFİL 1mt	KYS PP/72-1	51.450	20	8,6672 \$
PROFİL 2mt	KYS PP/72-2	51.475	20	17,3344 \$
KAPAK	KYS PK/72	51.500	50	0,3814 \$
AYAK	KYS PA/73	51.525	50	0,4949 \$



108mm PROFİL

ÜRÜN	ÜRETİM KODU	SİPARİŞ NO	ADET	BİRİM FİYAT
		YESİL		
PROFİL 1mt	KYS PP/108-1	51.750	20	10,1958 \$
PROFİL 2mt	KYS PP/108-2	51.775	20	20,3916 \$
KAPAK	KYS PK/108	51.800	50	0,4570 \$
AYAK	KYS PA/109	51.825	50	0,6052 \$



DİSTANS SERİSİ

RAY DİSTANS

ÜRÜN	ÜRETİM KODU	SİPARİŞ NO.			ADET	BİRİM FİYAT
		MAVİ	YEŞİL	TURUNCU		



RAY DİSTANS VİDALI	DISRD/1	60.300	61.300	62.300	100	0,2928 \$
--------------------	---------	--------	--------	--------	-----	-----------



RAY DİSTANS VİDASIZ	DISRD/0	60.340	61.340	62.340	100	0,3226 \$
---------------------	---------	--------	--------	--------	-----	-----------



SOĞUTUCU RAY DİSTANS	DISSRD	60.380	61.380	62.380	100	0,4128 \$
----------------------	--------	--------	--------	--------	-----	-----------

60,000 ve 61,000 sipariş no.lu ürünler stokta bulunur. Diğer ürünler için stok bilgisi alınız.

3,81mm KABLO BİRLEŞTİRİCİ RAY DİSTANS

ÜRÜN	ÜRETİM KODU	SİPARİŞ NO.		ADET	BİRİM FİYAT
		MAVİ	YEŞİL		



3,81 mm KABLO BİR. RAY DİSTANS+ DURDURUCU	DIS3,81/KB	60.420	61.420	200	0,2745 \$
---	------------	--------	--------	-----	-----------

61,000-sipariş no.lu ürünler stokta bulunur. Diğer ürünler için stok bilgisi alınız.

5,08mm ve 7,62mm KABLO BİRLEŞTİRİCİ RAY DİSTANS

ÜRÜN	ÜRETİM KODU	SİPARİŞ NO.		ADET	BİRİM FİYAT
		MAVİ	YEŞİL		



5,08 mm KABLO BİR. RAY DİSTANS	DIS5,08/KB	60.460	61.460	100	0,3158 \$
--------------------------------	------------	--------	--------	-----	-----------

60,000-sipariş no.lu ürünler stokta bulunur. Diğer ürünler için stok bilgisi alınız.

DİSTANS SERİSİ

DİSTANS					
ÜRÜN	ÜRETİM KODU	SİPARİŞ NO	ADET	BİRİM FİYAT	
		NATÜREL			
	PCB-PLEKSİ	600-KYD	69.500	200	0,0880 \$
600/KYD 10,6mm					
	PCB-PLEKSİ	601-KYD	69.540	200	0,1066 \$
601/KYD 22,5 mm					
	PCB-PLEKSİ	602-KYD	69.580	200	0.1003 \$
602/KYD 26 mm					
	PCB-PLEKSİ	603-KYD	69.620	200	0,1177 \$
603/KYD 31 mm					
	PCB-PLEKSİ	606-KYD	69.640	200	0,0846 \$
606/KYD 38mm					
	PCB-PCB	610-KYD	69.660	200	0,0825 \$
610/KYD 10mm					
	PCB-PCB	611-KYD	69.700	200	0,1000 \$
611/KYD 22.5mm					
	PCB-PLEKSİ	616-KYD	69.730	200	0,1216 \$
616/KYD 11mm					
	PCB-DESTEK	620-KDD	69.740	200	0,0809 \$
620/KDD 11mm					

PANO TERMOSTAT SERİSİ



TEK YÖN

ÜRÜN	ÜRETİM KODU	SİPARİŞ NO NATÜREL	ADET	BİRİM FİYAT
TEK YÖN	PTS T/1	79.100	10	13.50 \$



ÇİFT YÖN

ÜRÜN	ÜRETİM KODU	SİPARİŞ NO NATÜREL	ADET	BİRİM FİYAT
ÇİFT YÖN	PTS C/2	79.400	10	28.00 \$

DİĞER ÜRÜNLER

SİGORTA YUVASI



ÜRÜN	ÜRETİM KODU	SİPARİŞ NO	ADET	BİRİM FİYAT
SİGORTA KAPAĞI	SKAP	83.050	500	0,0333 \$
SİGORTA YUVASI	YUV	83.075	500	0,1094 \$

SOKET KÖPRÜSÜ



ÜRÜN	ÜRETİM KODU	SİPARİŞ NO	ADET	BİRİM FİYAT
5,08 mm SOKET KÖPRÜSÜ	MRS 5,08/SK	89.100	250	0,1511 \$
7,62 mm SOKET KÖPRÜSÜ	MRS 7,62/SK	89.125	250	0,2267 \$

KODLAYICI



ÜRÜN	ÜRETİM KODU	SİPARİŞ NO	ADET	BİRİM FİYAT
PC KODLAYICI ERKEK(TIPA)	MRS PC/KOD	85.150	500	0,0302 \$

VİDA



ÜRÜN	ÜRETİM KODU	SİPARİŞ NO	ADET	BİRİM FİYAT
KABLO BİRLEŞTİRİCİ VİDASI	DISKBV	89.175	200	0,0213 \$

ÖZEL TASARIM ÜRÜNLER



MOTOR KLEMENSİ

ÜRÜN	ÜRETİM KODU	SİPARİŞ NO SİYAH	ADET	BİRİM FİYAT
MRSP-500 ERKEK	MRS PF/500-E	99.020	25	5,3480 \$
MRSP-500 Dişi	MRS PF/500-D	99.030	25	6,1024 \$

YÜKSEK ISIYA DAYANIKLI MOTOR KLEMENSİ



ÜRÜN	ÜRETİM KODU	SİPARİŞ NO NATÜREL	ADET	BİRİM FİYAT
MGSE-015 MOTOR GÖVDESİ SOK. ERK.PC TARAF (7 KUTUP)	MRS015/E	99.040	100	5,3488 \$
MGSE-015 MOTOR GÖVDESİ SOK. Dişi TARAF (7 KUTUP)	MRS015/D	99.050	100	6,6724 \$
MGSE-016 MOTOR GÖVDESİ SOK.ERK.PC TARAF (7 KUTUP)	MRS016/E	99.060	100	4,3224 \$
MGSE-016 MOTOR GÖVDESİ SOK.Dişi TARAF (7 KUTUP)	MRS016/D	99.070	100	6,0958 \$

ÖZEL TASARIM ÜRÜNLER

DEVE BOYNU KLEMENS



ÜRÜN	ÜRETİM KODU	SİPARİŞ KODU GRI	FİYAT
NO:2 2'Lİ 7,62 DEVE BOYNU KLEMENS	DBK-2/2	24.470	
NO:1 DEVE BOYNU KLEMENS SOL	DBK-1/4SL	29.240	
NO:1 DEVE BOYNU KLEMENS SAĞ	DBK-1/4SĞ	29.241	

LED IŞIK TAŞIYICI



ÜRÜN	ÜRETİM KODU	SİPARİŞ KODU SIYAH	FİYAT
LED IŞIK TAŞIYICI	022-LIT	022-LIT	

ASANSÖR SİNYAL KUTUSU



ÜRÜN	ÜRETİM KODU	SİPARİŞ KODU	FİYAT
ASANSÖR SİNYAL YAYICI KUTU GÖVDE+KAPAK	017-ASYK-K	017-ASYK-K	
ASANSÖR SİNYAL KUTULARI	011-ASK	99.080	

ASANSÖR BAĞLANTI DAĞITICI KUTUSU



ÜRÜN	ÜRETİM KODU	SİPARİŞ KODU TURUNCU	FİYAT
ASANSÖR BAĞLANTI DAĞITICI KUTUSU	010-ABDK	99.100	

10,16MM SOKET SERİSİ İLE TANIŞIN!

Yüksek gerilimli alanlarda güvenli tutuş sağlar.

YAKINDA!

10,16 Serisi Erkek 90°

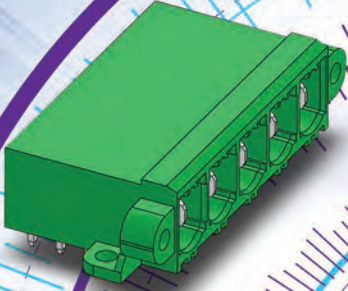

10,16 SKBK Serisi Dişi

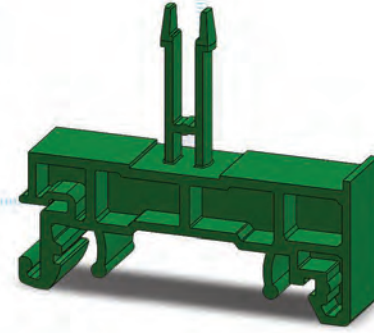
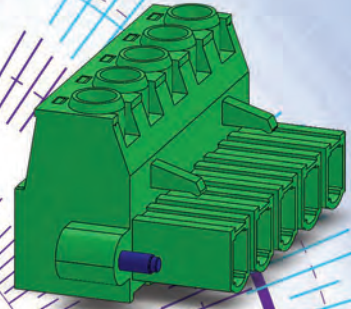

10,16 SKBK Serisi Ray Distans

10,16 Serisi Erkek 180°

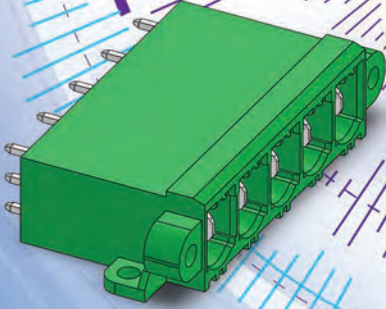

10,16 SKBK Serisi KB Erkek

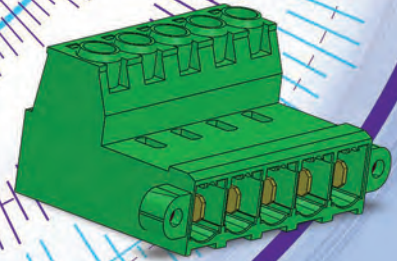

 MEGARADAR®

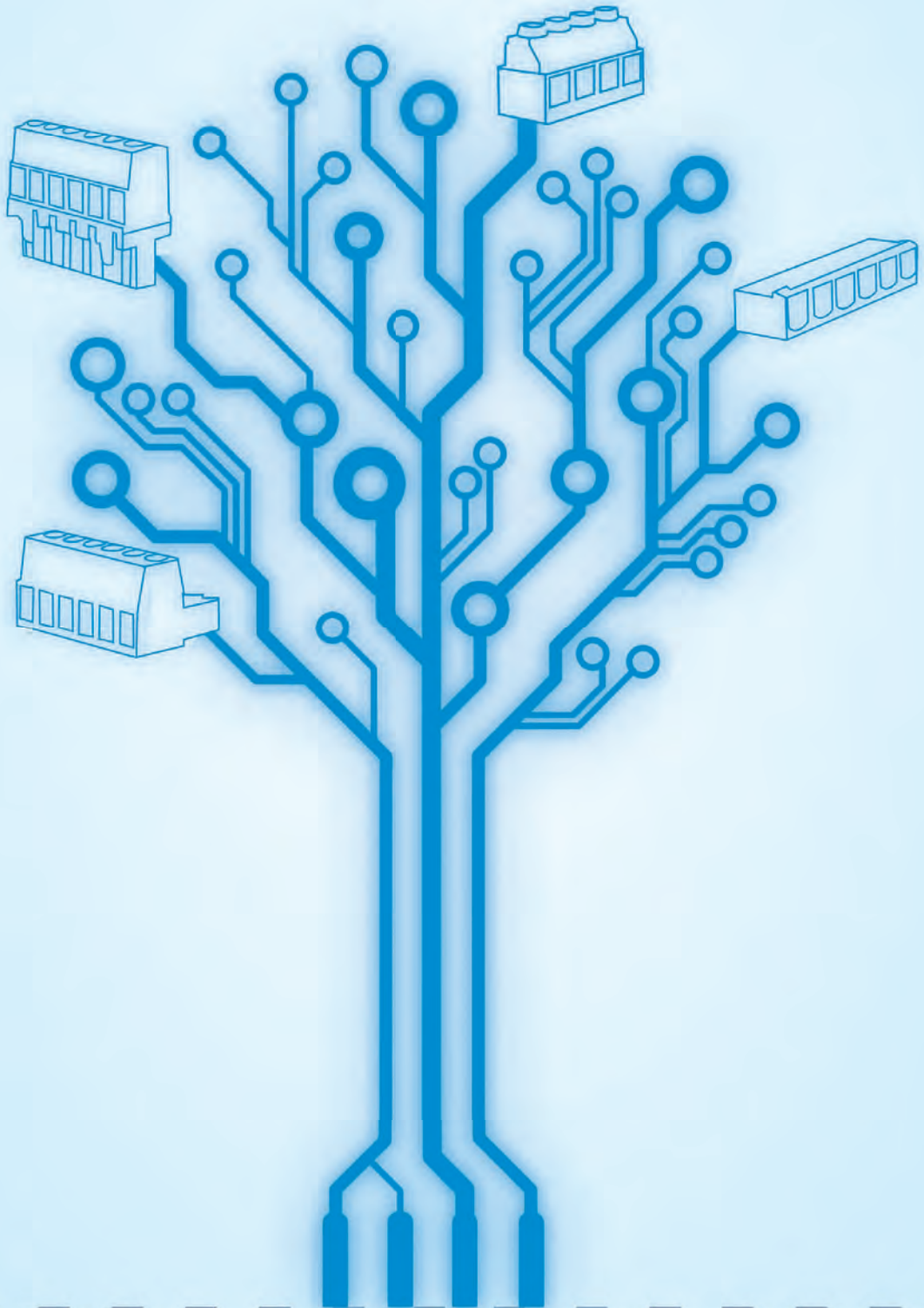

 **MEGARADAR**
Elektrik Elektronik İnşaat San. Tic. A.Ş.

Parseller Mah. Kuyu Sok. No:30 Ümraniye/İstanbul T : +90 216 632 90 04 - 634 12 06 F : +90 216 632 89 31

www.megaradar.com.tr